

# **HERALD**

## **Field Operational Test Evaluation Final Report**

**Castle Rock Consultants  
September, 2000**

## TABLE OF CONTENTS

EXECUTIVE SUMMARY .....	ii
1. INTRODUCTION .....	1
1.1 Purpose of Herald .....	1
1.2 Herald Participants.....	2
2. HERALD BACKGROUND.....	3
2.1 Herald History.....	3
2.2 Herald Cost .....	4
3. TECHNOLOGY .....	5
3.1 AM Radio Characteristics.....	5
3.2 KTLK AM .....	7
3.3 Herald System.....	8
3.4 Mikros AM Data Broadcasting System.....	13
4. TEST METHODOLOGY.....	17
4.1 Herald Testing Methodology .....	17
4.2 Mikros Testing Methodology .....	21
5. TECHNICAL TEST RESULTS.....	24
5.1 Herald Test Results .....	24
5.2 Mikros Test Results .....	30
6. INSTITUTIONAL ISSUES.....	32
6.1 Legal Issues.....	32
6.2 Commercial Issues.....	33
7. RECOMMENDATIONS.....	35
7.1 Herald.....	35
7.2 Mikros.....	37
8. CONCLUSION.....	38
8.1 Potential Market for Herald .....	38
8.2 Recommendations for Future Research.....	39
9. ACRONYMS.....	40
10. BIBLIOGRAPHY.....	41

## EXECUTIVE SUMMARY

The Herald Field Operational Test (FOT) tested AM radio as a low-cost way to broadcast traveler information in rural areas. It tested the feasibility of broadcasting data on the inaudible portion of an existing AM broadcast. Two systems were tested, the Herald system developed during the FOT, and a system from Mikros Systems Corporation. Both systems proved it is technically feasible to broadcast data over AM without degrading the audio programming. And both systems proved to be strong candidates for low-cost rural traveler information dissemination.

Herald took place in two phases. In Phase I, the message generation and method of imbedding the data in the AM broadcast were created. They were tested in laboratory simulations and refined to create a maximum throughput of data with undetectable audio content degradation. Then, the system was tested on a 10 Watt station with a coverage of about one square mile. This tested the over-the-air capabilities of the system. In the last effort of Phase I, the Herald system was temporarily installed at KTLK, a 50,000 Watt station in Denver for further over-the-air testing. In Phase II, the system was again installed at KTLK while the independent evaluator covered the Front Range of Colorado in a vehicle equipped with a Herald receiver and data collection equipment. The evaluator collected data over two days and one night before KTLK discontinued the Herald test because of an unexpected conflict with a small percentage of stereo AM radios.

The Mikros system was tested later. Mikros delivered their completed, proprietary system to the evaluator. It was installed at KTLK and run for six days while testers covered the state in a vehicle equipped with a receiver and data collection equipment.

The system developed during Herald proved to be the more robust of the two, providing a coverage of up to 100 miles from the broadcast tower in which traveler information messages could be received. The system provided a data rate of 120 bps, which will allow for as many as 180 messages per minute. The Mikros system delivered a much higher data rate, approaching 3000 bps, but its range was considerably more limited with virtually no reception over 30 miles from the broadcast tower.

The costs of both systems are low. Herald broadcast equipment costs less than \$10,000 and a receiver and display unit likely costing well under \$200. Mikros broadcast equipment is less than \$5,000 and the cost of a receiver and display unit is unknown, but likely to be similar to Herald.

Both systems appear to be suitable solutions for the growing need for en-route traveler information. The systems can be used to disseminate information to in-vehicle receivers as well as Personal Digital Assistants and other mobile devices that can receive and display information.

While the FOT was limited by some shortcomings in the systems, those can likely easily be overcome with a little more research, and AM data broadcasting can help to improve the safety and efficiency of rural travel.

## 1. INTRODUCTION

Herald is a Federal Highway Administration (FHWA) Field Operational Test (FOT) begun in 1994. It was conceived and initiated by the ENTERPRISE program and funded by ENTERPRISE and FHWA.

The FOT had two phases. In the first, it developed a low-cost means for disseminating traveler information over large rural areas where cellular and landline service are not available to travelers. In the second phase, field tests were performed to measure the effectiveness of the developed system.

The Herald system employed the inaudible portion (the subcarrier) of an AM broadcast to transmit traveler information data. AM radio has the ability to penetrate some rural mountainous and plains locations better than any other wireless method. This is because of the existence of AM radio infrastructure in rural areas and the propagation characteristics of the medium-wave channels used for AM broadcasting.

### 1.1 PURPOSE OF HERALD FOT

Herald was developed to achieve three specific and measurable objectives. These objectives were:

1. *To test a subcarrier on AM as a reliable, low-cost medium for transmitting traffic messages over wide geographic areas.*

Operating characteristics of subcarriers on AM for Intelligent Transportation Systems (ITS) applications had not been explored in the United States broadcasting environment. AM radio offered a low-cost means for wide-area coverage of low-speed data transmission. During the testing, data was collected and evaluated for a range of geographies, including mountains, urban centers and plains.

2. *To examine the institutional issues and barriers in utilizing AM commercial radio stations for broadcasting traffic messages over subcarriers.*

The institutional barriers and legal issues have proven to be difficult impediments to deployment of many ITS systems. The objective was to identify potential barriers and then to determine a means for overcoming them.

3. *To test the suitability of the Intelligent Transportation Information Interchange System (ITIS) BIF (bearer independent format) and AM BAP (bearer application protocol) documents.*

ENTERPRISE developed ITIS as an open, non-proprietary, modular set of standards

intended to serve the public interest by facilitating the interconnection of traffic and traveler information systems. This preceded the development of the National ITS Architecture and the FHWA-funded national standards development organizations (SDO). The message sets and protocols of the SDOs will be supported by ENTERPRISE, and the use of ITIS standards was counter-productive.

While the ITIS common specifications were not tested during Herald, the tests were designed to be generic enough to evaluate whether any standard could be successfully used over the AM subcarrier.

## **1.2 HERALD PARTICIPANTS**

The Herald testing took place in two cases. In the first case, testing involved the partners described in the original FOT plan. They were:

- Mobile Data Systems (MDS) – developers of the AM data broadcasting system;
- Modulation Sciences, Inc. (MSI) – providing expertise in AM broadcasting;
- Clear Channel Communications (formerly Jacor) – providing the AM station used for broadcasting;
- The ENTERPRISE Program – providing technical and financial support. ENTERPRISE is a multi-jurisdiction pooled-fund ITS research organization;
- FHWA - providing financial and institutional support
- Castle Rock Consultants (CRC) – independent system evaluators; and
- National Telecommunications and Information Administration (NTIA) – independent system evaluators.

In the second case, MDS had gone out of business and was not used in any capacity. MSI was also not used. A promising new AM data broadcast technology developed by Mikros Systems Corporation was tested. The participants were:

- Mikros Systems Corporation – developers of the AM data broadcasting system;
- Vir James Engineering – providing expertise in AM broadcasting and coordination with Clear Channel Communications;
- Clear Channel Communications – providing the AM station used for broadcasting;
- The ENTERPRISE Program – providing technical and financial support.
- FHWA- providing financial and institutional support
- CRC – independent system evaluators; and
- NTIA – independent system evaluators.

## 2. HERALD BACKGROUND

### 2.1 HERALD HISTORY

The original Herald FOT took place in two phases. In Phase I, an AM subcarrier for disseminating traveler information was determined. MDS, a consultant to ENTERPRISE, developed optimal coding strategies for placing a silent data stream on the subcarrier. They also built a prototype in-vehicle unit capable of receiving the data stream, and the transmission equipment suitable for testing different AM modulation schemes and error correction methods. Once the best approach was identified, off-air channel interference tests were performed, leading to a limited on-air and over-the-road system test. Testing continued by moving it to on-air using a low-power (10 watts) AM broadcast on an unused channel in Boulder, Colorado.

Phase II expanded the FOT by performing meaningful field tests. The transmission equipment built by the consultant was installed at KTLK, 760 AM, described in more detail in Section 3.2. It broadcast a Herald data stream while a vehicle equipped with prototype receivers traveled throughout the Front Range of Colorado, receiving the broadcast. The testing was designed to determine the accuracy and reliability of the AM subcarrier as a medium for broadcasting the data stream.

The Herald system negatively impacted KTLK's broadcast quality. The data was placed on the portion of the broadcast that is not audible to the listener. However, some AM radios use a "pilot tone" in this inaudible range to detect a stereo broadcast. The pilot tone triggers the radio to demodulate the incoming signal as stereo. Herald triggered Motorola radios to decode the monophonic signal as stereo, resulting in Awhite noise, or background distortion. For this reason, the testing at KTLK was limited to a few days.

Testing was halted and the consultant attempted to fix the interference with some AM stereo radios. However, MDS went out of business before resolving the problem. ENTERPRISE contacted several radio engineers in an effort to modify the Herald system, but due to financial constraints and a lack of documentation, these attempts were unsuccessful.

In early 1999, ENTERPRISE was contacted by Mikros, Inc. Mikros had developed an AM data broadcasting system that promised much higher data speeds than the Herald system. It was similar in its capability to be implemented at low-cost, and in previous testing had not triggered any AM stereo radios. ENTERPRISE chose to continue the field testing using the system developed by Mikros rather than spend project resources trying to modify the previous system. In September 1999, Mikros delivered their AM data system to Denver and it was installed at KTLK. A week of testing followed.

This report includes the results of the testing of both systems. The intention is to provide the reader with an understanding of the state of AM data transmission, the differences

between the two systems, the feasibility of each as a commercially viable data dissemination source, and the potential for either system to be deployed on a large scale.

## 2.2 HERALD COST

The Herald Field Operational Test was funded through cash and in-kind contributions from FHWA, ENTERPRISE and its members, MDS and CRC. Because Herald was not completed in the manner anticipated in its original scope, the project did not spend its entire budget on the test. Rather, a portion was used to fund Phase III, the evaluation of the Mikros equipment.

The monetary costs of this FOT are detailed in Table 1. They are divided into the three phases of the project; Herald development, Herald field testing and Mikros testing. Further, they are divided into costs for system development, project management and evaluation.

*Table 1. Herald Costs*

<b>Phase</b>	<b>Development</b>	<b>Project Management</b>	<b>Evaluation</b>	<b>Total</b>
Phase 1 – Herald system Design and Development	\$95,842	\$14,631	\$0	<b>\$110,473</b>
Phase II – Field Testing	\$225,000	\$35,023	\$24,967	<b>\$284,990</b>
Mikros Testing	\$4,000		\$21,924	<b>\$29,924</b>
<b>Total</b>	<b>\$324,842</b>	<b>\$49,654</b>	<b>\$50,891</b>	<b>\$425,387</b>

Mikros provided its equipment and technical support expertise at its own expense during Phase III. The only development cost directly incurred by the project was a \$4,000 direct expense for Denver-based radio engineering firm Vir James to help install the equipment at KTLK and to trouble-shoot the system once it was operating.

The cost of the Mikros Testing evaluation includes the cost of this final report and the evaluation of the Mikros equipment.

The development expenditures were wholly from MDS and MSI, with the exception of \$4,000 spent by Vir James. The project management and evaluation expenses were from CRC. NTIA in Boulder provided in-kind support for the evaluation as seen above in Table 1.



### 3. TECHNOLOGY

As previously discussed, two systems were tested during Herald. The first was the Herald system developed during Phase I. The second was the proprietary system developed by Mikros. In this section, the characteristics of AM radio and the technology and methodology of the two systems are described.

#### 3.1 AM RADIO CHARACTERISTICS

AM, or Amplitude Modulation, is a medium-wave frequency. It covers the frequencies from 540 Kilohertz (kHz) to 1800 kHz. Medium wave frequencies have medium wavelengths, with lengths from 167 meters (546 feet) to 555 meters (1820 feet).

The purpose of radio is to convey information from one place to another through the intervening media (i.e., air, space, nonconducting materials) without wires. Besides being used for transmitting sound, AM radio can be used for the transmission of encoded data, such as that tested in Herald.

A radio wave acts as a carrier of information-bearing signals; the information may be encoded directly onto the wave by periodically interrupting its transmission (as in dot-and-dash telegraphy) or impressed on it by a process called modulation. Herald and commercial AM radio use the latter technique. In AM transmission, the actual information in a modulated signal is contained in its sidebands. The carrier wave is constant in frequency and varies in amplitude (strength) according to the sounds or data present at the origin. (For comparison, in FM the carrier is constant in amplitude and varies in frequency.) Because the noise that affects radio signals is partly, but not completely, manifested in amplitude variations, wideband FM receivers are inherently less sensitive to noise. The variance is detected by the receiver and decoded into information. In general, Frequency Modulation (FM), minimizes noise and provides greater fidelity than amplitude modulation, which is the older method of broadcasting.

In its most common form, radio is used for the transmission of sounds (voice and music) and pictures (television). However, there are many examples of data transmission along with sound or images that do not impact the quality of the primary broadcast. Some examples are closed captioning systems on televisions, or Radio Digital Broadcast Systems (RBDS), found on the FM band.

To create a signal for AM transmission, sound or data is converted into electrical signals by a microphone or computer. They are amplified, and used to modulate a carrier wave that has been generated by an oscillator circuit in a transmitter. The modulated carrier is also amplified, then applied to a broadcast antenna, or series of antennas, that converts the electrical signals to electromagnetic waves for radiation into space. KTLK, the radio

station used for Herald testing, had four antennas and alters the timing of the transmission from each antenna in order to be able to direct their broadcast.

At the reception end, a radio separates the signal from the carrier wave. Then they are fed to a loudspeaker, where they are converted into sound, or to a device where they are converted to data.

### ***3.1.1 Ground Wave Performance***

Ground Wave is one of the two waves for AM propagation. It is a function of ground conductivity. AM radio waves are able to travel significant distances over both wet and dry surfaces, notably further over wet. A broadcast at 1 MHz (1000 on an AM radio) can be heard with only moderate quality loss over 300 miles away over wet surface, and over 200 miles away over dry surface. It is this ability to carry long distances that makes AM technology ideal for the rural environment.

### ***3.1.2 Sky Wave Performance***

Sky waves are the other form of propagation for AM radio. It is much more unpredictable than ground wave propagation due to the uncertainty in the layers of the ionosphere, which vary according to solar and atmospheric conditions. Often, sky wave propagation allows for AM signals to carry several hundreds of miles, usually farther than during the day. KTLK, the station used during Herald tests, “powered down” from 50,000 Watts during the day to 1,000 Watts at night, reducing its range so that its propagation would not interfere with other stations at 760 AM in other parts of the country.

### ***3.1.3 Advantages of AM Radio***

The primary advantage of AM radio over FM radio is its ability to cover large rural areas with a single radio station. While there are more FM than AM stations in the United States, AM has more complete coverage in the rural areas. Additionally, these stations are often independently run. This may result in a less complicated opportunity for public and private sector agencies seeking to use the unused portion of their broadcast spectrum.

AM characteristics also result in superior coverage of hilly, mountainous or canyon territories. FM is generally limited to reception by devices with the broadcast towers “line of sight,” while AM is not.

### 3.2 KTLK AM

KTLK broadcasts at 50,000 Watts during the day and 1,000 Watts at night. Its broadcast tower is located 15 miles directly north of Denver, east of Interstate 25 in the suburb of Thornton. The area around the broadcast tower is flat and rolling hill. The location and daytime field strength of the station can be seen in Figure 1.

KTLK is primarily a talk radio station with an emphasis on sports and business. It is owned by Clear Channel Communications, a multinational corporation that owns 183 radio stations. This project's interactions with the station were through Clear Channel radio engineers.

The station has four antennas. It uses all four at night and two during the daytime. The use of multiple antennas results in a directed signal that can be broadcast more strongly in a desired direction. KTLK broadcasts are directed west and during the daytime a strong signal is received strongly throughout the metro Denver area.

Map source: U.S. Census Bureau

*Figure 1. Daytime field Strength of KTLK*

### 3.3 HERALD SYSTEM

The Herald System featured hardware installed at the broadcast tower that cost less than \$10,000 and could be installed in less than two hours. The receiver was a slight modification of a stereo AM car radio that output data to a laptop for display and data collection as seen in figure 2.

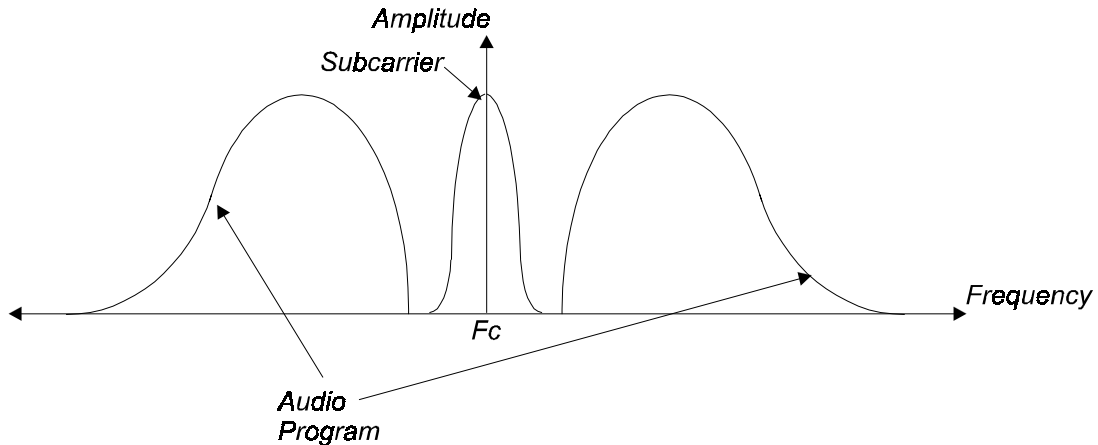

Figure 2. Herald subcarrier data placement on AM channel

#### 3.3.1 Transmission

The data transmission included all components that were required to generate and send data to the radio station antennas. They included the means for creating messages, encoding them, generating them and inputting them onto the inaudible portion of the radio station's regular signal as seen in figure 3.

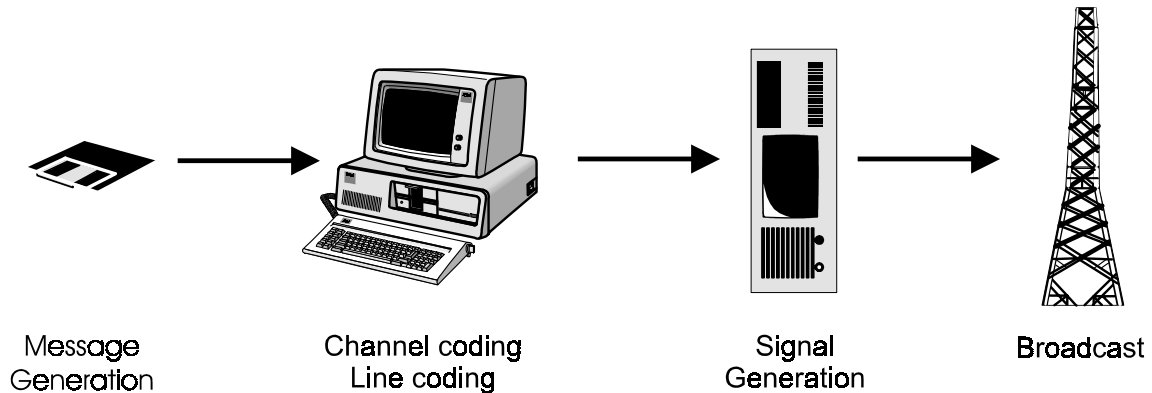

Figure 3. Herald System Data Transmission Flow Chart

#### Message Generation

The "transmit" software developed by MDS was able to read any data file and convert it into a data stream suitable for broadcast. The arbitrary data file could be any text or binary format file. The data files could be edited by any individual with access to the file.

In the case of Herald testing, the file resided on a computer at the transmission site. However, the file could also be sent to the transmission tower from anywhere using the Internet. Because the data was arbitrary ASCII-compatible data, the ITIS codes, or any other binary message set could be used.

### Channel Coding

Prior to transmission, the raw binary data (arbitrary data file) was channel coded. There were several reasons for channel coding, primarily that it allowed for the detection and correction of some bit-errors, or simply the detection of bit errors. A bit error is a single bit (a “1” or “0”) that is sent incorrectly, or altered during transmission, so that the receiver receives a different bit than was sent.

A bit error can impact an entire message, which is made up of a string, or packet, of bits. For example, a single ASCII character, such as a letter of the alphabet, is made up of eight bits, and an error in one bit would result in the transmission of the wrong character. If the error can be detected and corrected, then the entire message can be saved. However, if an error is detected, but the system is unable to correct it, then the entire string should be discarded.

The system’s choice between detection followed by correction and detection followed by discarding depends on the operational environment of the communication system. For the operational environment of Herald, a bit error detection followed by discard approach was taken. The primary reason was because each encoded message was repeated, so if a message were discarded as incorrect, a redundant message would follow and the traveler would eventually receive the correct message. Also, the risk of accepting an incorrect message could be catastrophic if a traveler is given the wrong information.

### Line Coding

In a digital communication system, “line coding” refers to the mapping of logical binary values (“1” and “0”) to analog voltage levels. In other words, each binary value is associated with only one voltage. In the AM system, it is necessary to use AC coupling to limit signal generator frequency drift to within commercial AM radio Federal Communications Commission (FCC) specifications of +/-10 Hz. Greater drift could result in interference to and from neighboring radio stations.

A Non-Return to Zero (NRZ) baseband line coding was used for the Herald System. It was selected because it exhibited minimum bandwidth (preserving more bandwidth for data coding) and a minimum probability of bit error.

### Signal Generation

The use of NRZ baseband line coding required the use of a signal generator with direct current frequency response. The signal generator selected was not truly DC, but simulated it closely enough to be acceptable. However, it cost nearly \$10,000, effectively doubling the hardware cost of the installation. Less expensive signal generators could be used, but they create signal drift greater than the FCC’s 10 Hz mandate.

### Broadcast

The signal generator amplified the amplitude of the inaudible subcarrier prior to the signal being sent to the antennas. Once the data was encoded in the amplified inaudible subcarrier, it was broadcast, with the intended result being no detectable degradation of the audible portion of the carrier.

### **3.3.2 Data Reception**

In its initial phase, the Herald System employed an AM stereo car radio rather than develop a new receiver. Later, a dedicated radio-independent receiver was built. The output from the receiver was fed into a laptop computer that displayed the text string decoded by the radio as seen in figure 4.

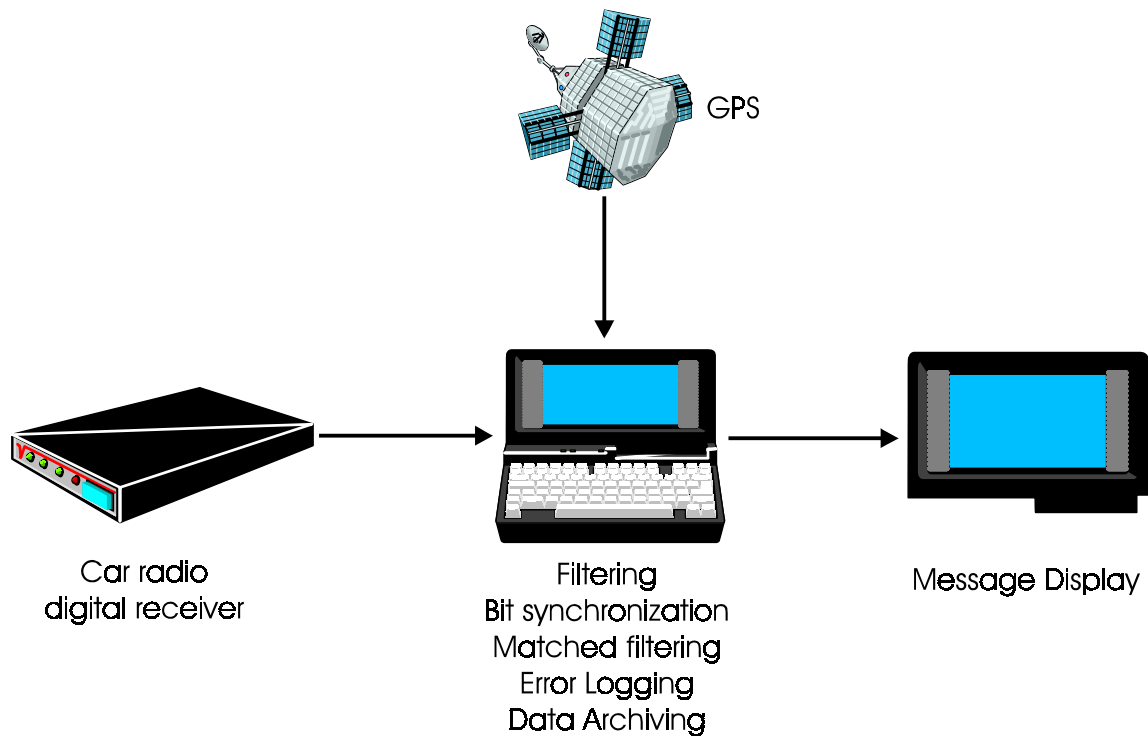

*Figure 4. Herald Data Reception Flow Chart*

### Car Radio Digital Receiver

In order to save time and money, a car radio with a stereo decoder chip was modified to decode the digital bit stream encoded on the AM station subcarrier by the transmission equipment. Later, a receiver board was built that would operate independently of the radio, so it could be connected to the most convenient AM radio available. This was done in part to save money during the testing phase, and in part to illustrate to radio manufacturers how easily this system could be integrated into their existing radio designs. The customized receiver showed significantly improved performance compared to the modified AM radio.

The car radio was then connected to a laptop computer for data display. The display of the laptop computer was set up to show the data stream as it was received by the radio. The laptop computer was an off-the-shelf Compaq with a Global Positioning Satellite (GPS) receiver card installed. Data was input through the laptop's existing I/O ports, and the GPS card was used to stamp a time and location on all data.

### Filtering

Mobile Data system built an Intersymbol Interference (ISI) removal finite impulse response filter to improve overall Systems performance. ISI results when transmitting digital data over a band-limited channel. AM radio is band-limited because the main carrier can only be 25-50 Hz in spread. The ISI filter was required to minimize the probability of bit errors.

### Bit Synchronization

Digital communications systems operate asynchronously between transmitter and receiver. This means that their clocks are independent and therefore data cannot be synchronized between broadcast and reception times. In other words, there is no way for the radio to know exactly what message should be expected at a certain time because it does not know what time the broadcast tower is operating on.

The digital-receive software on the laptop processes the soft bit stream as it is input from the receiver. With each bit it receives it must decide whether it is a zero or one. For optimal performance, the receiver processor processes information contained in the soft bit stream over an exact bit interval. It must make a decision based on the input and its knowledge of an existing or expected pattern, then move on to the next bit.

For bit synchronization, the best waveform is a constant pattern, such as alternating ones and zeros, where the receiver can easily decide which bit comes next based on what it has received. However, the result of these schemes is no data sent, just alternating bit patterns that impart no data. Other schemes required the use of significant bandwidth for the synchronization, reducing the already low data rate.

MDS eventually selected a squarer-bandpass algorithm that was coded into the receiver hardware for synchronization. It was chosen because it would not require significant bandwidth that would further limit the low-speed data transmission. The tradeoff, however, was the greater chance for error than if other methods, such as Bipolar RZ or other line codes, were used.

### Matched Filtering/Bit Decisions

Often a signal is corrupted between the transmitter and receiver by white noise. Sources of white noise that cannot be completely corrected by filters include shadowing from other broadcasts, impulsive noise from power lines, lightning, seasonal variations, and even interference from the car's power source. While the Herald system was able to flawlessly decode the radio broadcasts while stationary in a laboratory, the unpredictable nature of interference in the real world guaranteed less than perfect results during field-testing.

### Channel Decoding/Word Synchronization

After bit synchronization, matched filtering and bit decisions have been completed, the data still must be processed. The bit stream is ported from the receiver to the laptop computer for interpretation into messages.

The data stream entering the laptop must be coded into blocks for correct information decoding. In Herald System testing, the data was sent as ASCII characters, which are made of eight bits each (one byte). In order for the laptop to be able to determine the beginning and ending of blocks, they had to be a predetermined length. The packets for this testing were 40 bits, or five bytes.

A complete ENTERPRISE ITIS code message is 37 bits long, so the 40-bit length chosen for this testing is an appropriate sample length to verify that complete ITIS codes can be sent within system blocks.

### Error Logging

Once the incoming message laptop was synchronized, it was compared to a copy of the message stored on the computer. It compared each character, or byte, to determine if there were any errors. A mismatch between an incoming character within a message and that character in the stored message meant that there was at least one bit-error within the byte that comprised that message.

Data logs, including error rates, were written to a file for analysis, and the results are shown in Section 5.

### Message Display

Once the blocks were synchronized and decoded by the laptop, they were displayed on the laptop screen as a message. The user could tell almost immediately whether the correct message was being sent from the string of characters that appeared. Misspellings or characters out of place would mean there were errors. As previously discussed, a single bit error will corrupt an entire byte.

### ***3.3.3 Potential Costs of an Operational System***

The herald system can be deployed very inexpensively, both on the broadcast and reception sides. The equipment described in section 3.3.1 can be purchased and installed for less than \$10,000 per station. The same equipment can be installed on stations from ten to 50,000 Watts. On the receiver side, it was estimated that existing stereo AM radios could be modified to receive the Herald data stream for less than one dollar in parts. A display screen and processor would also be required, but these could likely be manufactured for under \$100 per vehicle.



### 3.4 MIKROS AM DATA BROADCASTING SYSTEM

The Mikros system is proprietary and cannot be disclosed in its entirety here. The basic principle of encoding data on the inaudible portion of an AM broadcast is the same. However, the Mikros system has the potential for data rates more than ten times higher than the original Herald system. The following discussion is a general overview of the Mikros methodology.

The Mikros system is a joint venture between Mikros Systems Corporation and Safeguard Scientific, which owns all proprietary rights to their AM broadcasting technology. Their objective is to sell the system to content providers, and not be content providers themselves. A public or private sector agency could use it to package and disseminate traveler information.

#### 3.4.1 Data Transmission

Because the system is proprietary, Mikros has provided basic information about how the message generation and transmission is preformed. The following is a summary of their explanation. Figure 5. shows a high-level view of the data creation and transmission process.

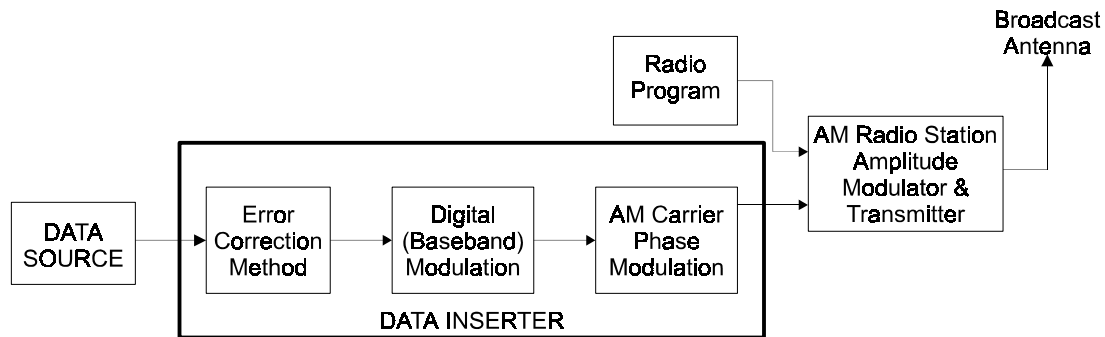

Figure 5. Mikros system data creation and transmission

#### Data Source

The data source is the message set that is intended to be broadcast. In the case of Herald, it was to represent a traveler information broadcast. For testing, a random stream of numbers was generated and used as the data source.

If the Mikros system were to be used for actual traveler information dissemination, the random stream of numbers would be replaced by encoded messages, such as ITIS codes or the standards developed by the SDOs.

#### Data Inserter

The data inserter is a series of software applications placed on a computer that shape the data source into a format that can be placed on the existing AM broadcast with minimal impact to the audio content. Its function is to convert the data source into a transmitted

stream of information by embedding it into the radio station signal by orthogonally phase modulating the carrier.

The error correction coding used by Mikros was not reported, but it is assumed that it operates under the same principles and is used for the same reasons as the error correction methods employed by the Herald system.

Digital modulation is the shaping of the data into digital data that can be embedded on the AM subcarrier.

The AM Carrier Phase Modulation is the final step before the system places its data on the broadcast. At this stage, the data is orthogonally phase modulated and embedded into the carrier.

Broadcast

The Mikros system inputs the digital stream into the transmitter independent of the audio content an AM station normally broadcasts. Both the normal audio content and the data stream are simultaneously fed into the station’s transmitter.

**3.4.2 Data Reception**

The system described by Mikros and the system tested were slightly different. The primary difference was that the system tested used a receiver built by Mikros and not an AM car stereo. Figure 6. illustrates the system as described by Mikros. It is followed by a discussion of the proposed and actual components used.

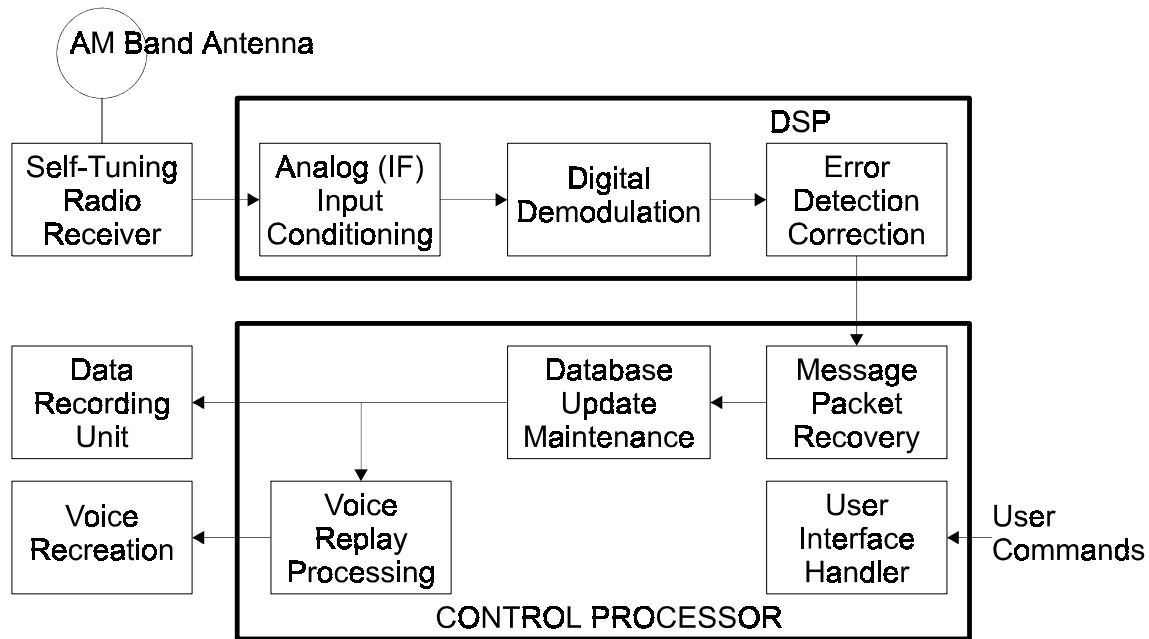

Figure 6. Mikros system data receiver

### In-vehicle Reception

The Mikros system plugged directly into the existing car antenna. Because testing took place in several vehicles, a portable antenna was purchased to insure that the quality of reception would be independent of the quality of the different vehicles' antennas.

Where the Mikros system diagrammed above shows a self-tuning radio at the front of the reception system, the Mikros equipment provided contained a receiver hard-wired to the digital signal processor (DSP). Investigations by Herald staff found that a car radio could be used rather than the existing receiver, however.

### Digital Signal Processor

In the Mikros model, the received broadcast is sent to the DSP for demodulation. The DSP performs three functions. The first is that it picks up the analog AM signal and conditions it. The conditioning is a cleaning of the noise surrounding the desired signal. The next step is demodulating the digital coding that has been embedded in the sidebands. Finally, the DSP detects and corrects errors. The type of error correction used by Mikros was not reported so it cannot be compared to the types used by the original Herald system.

### Control Processor

The corrected digital stream is sent from the DSP to the control processor where it is parsed into packets. Similar to the message synchronization for the original Herald system, a header indicates the beginning of new packets of data. In the Mikros system, the packets are considerably larger than in the Herald system. This is feasible because the Mikros system has a considerably higher data rate and therefore, synchronization happens almost as often in terms of time as in the Herald system, while fewer overall bits are used for synchronization.

Database update maintenance checks the received message with the expected message. They are compared at the bit level, with each received bit compared to the expected bit, and differences are detected as errors.

In the system tested there were no user commands and no user interface handler. The receiver and demodulator were a solid state unit that only allowed for toggling between receiver settings for either distant or local AM station reception.

The proposed Mikros system also allows for the audible, or voice, portion of the AM broadcast to be sent to speakers directly from the custom data receiver. The receiver tested did not do this, but it would not be a difficult feature to add. The receiver would also then emulate a self-contained radio with data reception capabilities.

Once the received data stream is checked against the expected data stream, the results are logged by the data-recording unit. The data recording unit is a laptop PC running a proprietary program developed by Mikros named "Data Logger." It documents not only the bit error, but also the phase modulation error.

### ***3.4.3 Potential Costs of an Operational System***

Similar to Herald, the Mikros system can be deployed inexpensively. The equipment at the broadcast station is a modified personal computer and cabling that connect directly to the transmitter. These could be installed for under \$3,000 per station. It is unclear what the in-vehicle costs are because Mikros developed their own radio receiver. Vir James Engineering indicated that a stereo AM radio could be inexpensively modified to serve as the receiver but no cost estimate was developed.

## 4. TEST METHODOLOGY

Both systems were tested by driving a test vehicle, or set of test vehicles, throughout Colorado's range of climatic and geographic conditions. The initial plan was to test the Herald system for six months, during summer, fall and winter, throughout the state. However, because of difficulties with the initial system, its testing was cut short at the request of KTLK.

Budgetary and time constraints limited the testing of the Mikros system to six days. Because this is a commercial system, developed independent of this operational test, it is assumed that further testing and refinement will be performed by Mikros. The testing performed here was to verify that it was a viable, and potentially superior, alternative to the Herald system.

### 4.1 HERALD TESTING METHODOLOGY

The original Herald Testing took place in December, 1996. The Herald equipment was installed at KTLK on December 6, 1996 and operated until December 13, 1996. During that time, the Herald system broadcast data continuously. For the first five days, MDS modified the signal they input into the 50,000 Watt broadcast, and on December 11<sup>th</sup>, declared the system ready for field testing.

KTLK noted that the Herald system created significant "white noise" in some AM stereo car receivers. The test, which used Chrysler AM stereo car receivers, could not detect this white noise. It was later learned that it was Motorola brand receivers, which is the brand installed in Fords, Mercurys and Lincolns. More discussion of this problem can be found in section 7.

Because of the white noise and the resulting complaints from listeners, KTLK decided to take the Herald system off the air on December 13, 1996. Because the system was only fully operational on the 11<sup>th</sup>, the result was only two days of field testing.

#### 4.1.1 *Testing Location*

The Herald Testing took place throughout the Front Range of Colorado, with the KTLK transmitter as the focal point. The routes taken by the testers are shown in Figures 7 and 8.

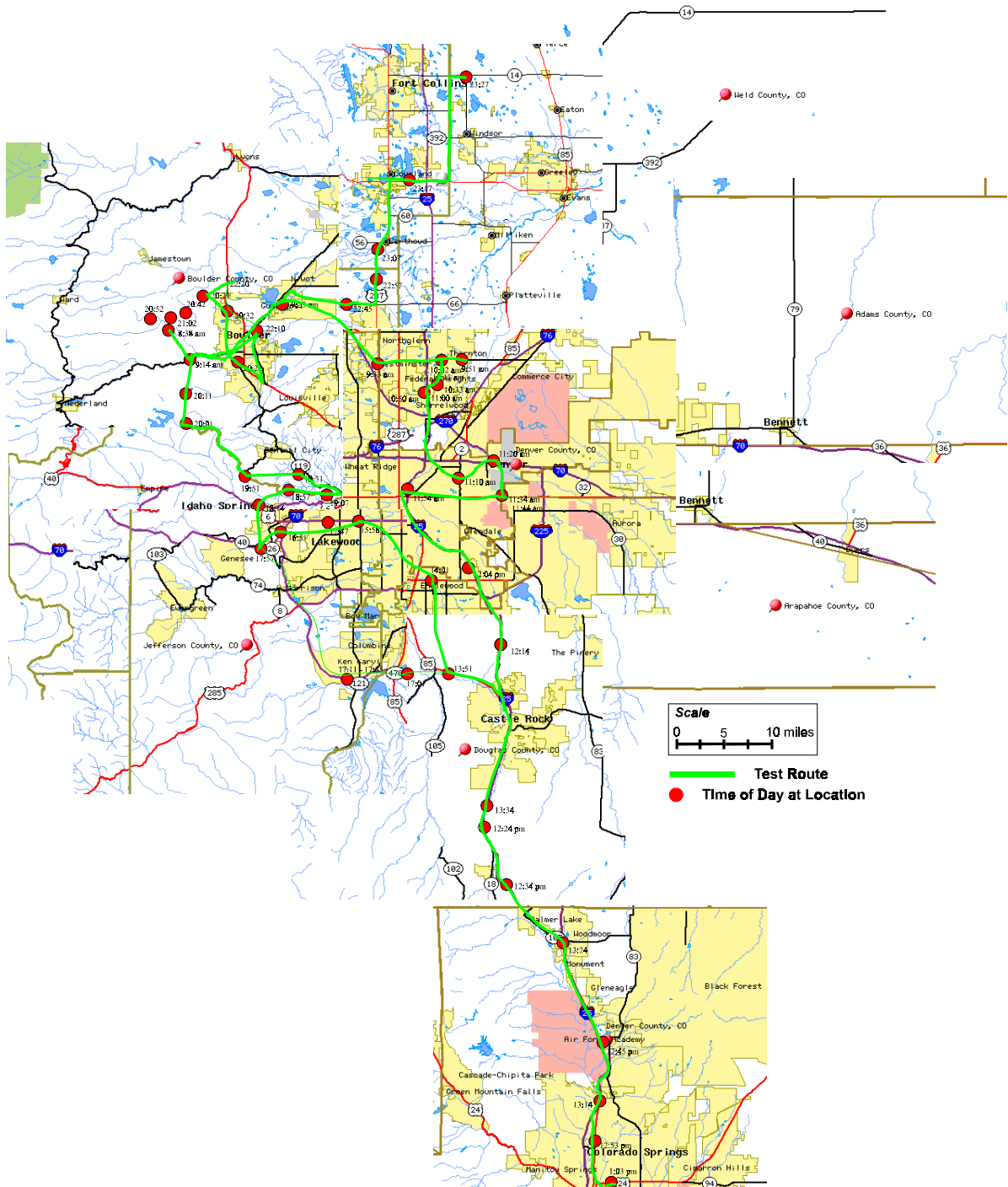

Figure 7. Route Map for December 11, 1996 Herald Testing

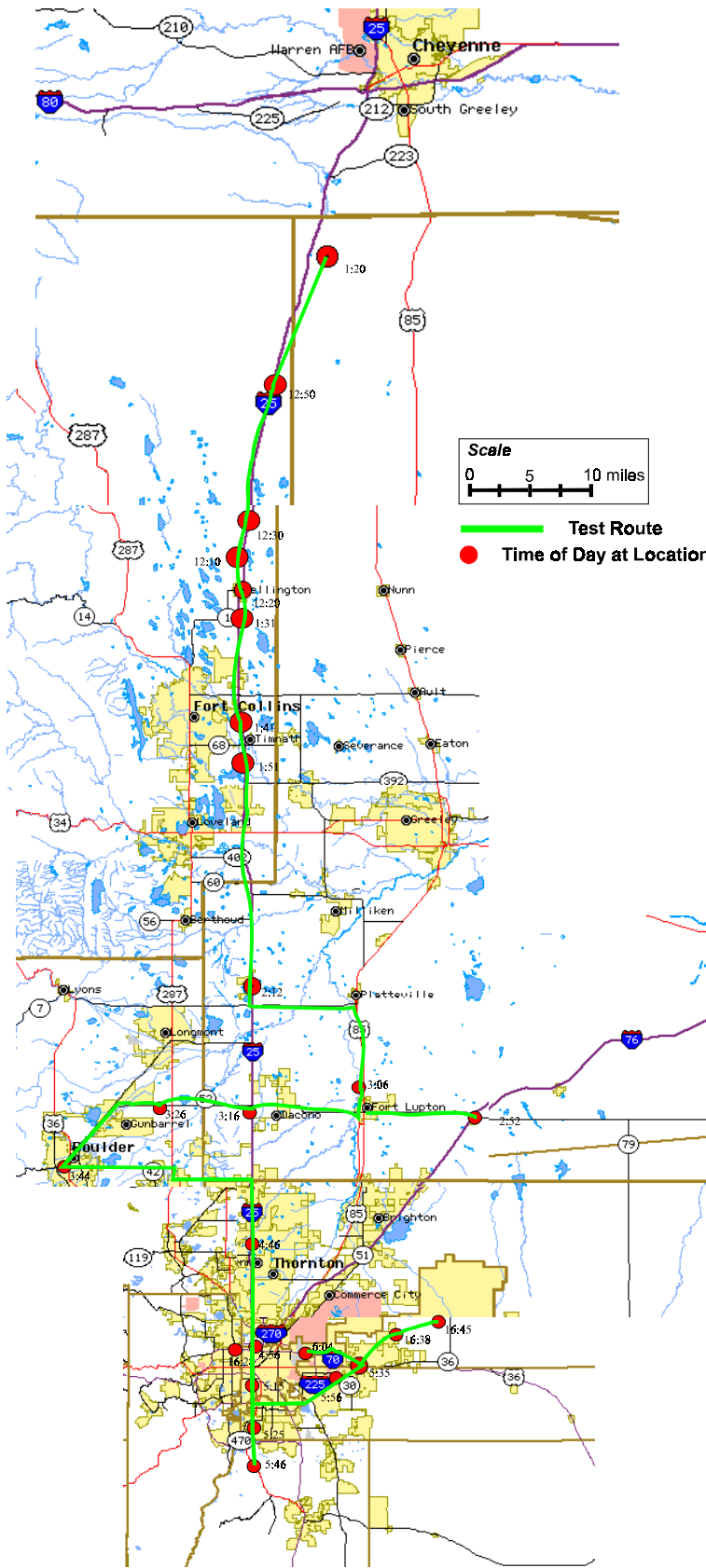

Figure 8. Route Map for December 12, 1996 Herald Testing

### 4.1.2 Testing Procedures

The testing began on the morning of December 11, 1996 from Boulder and ran almost continuously through that day and into December 12<sup>th</sup>. The purpose was to collect as much data as possible in the brief window available for testing.

A single vehicle was used for all field testing. It was equipped with the modified Chrysler radio connected to the vehicle's original equipment antenna, and a laptop computer. An antenna for the laptop's Global Positioning System (GPS) card was mounted on the roof. The system is described in Section 3.2.

There were two people in the testing vehicle, a driver and a navigator who also operated the equipment. This required insuring the equipment was receiving power, restarting the receiver after the car had stopped, such as for gas or lunch, and monitoring the onscreen display to verify that the computer was operating and messages were being received.

During the testing, the system worked continuously and it was stopped only briefly. The stops were for fueling, eating, resting, and often to save the file that data was being logged to before the file became too large to manipulate later.

Because the testing was over more than a 24-hour period, the testing includes data collected during day, night, and sunset. This is particularly valuable to assess the effect of the night wave propagation and the impact on the system of KTLK's "power-down" to 1000 Watts at sunset.

Log files were saved several times each day. The log files record the status of data received. The Herald system log files documented the following:

- Time stamp – the time the data was logged by the computer;
- Bits – the cumulative number of bits received by the receiver;
- Errors – the cumulative number of errors detected by the laptop in the bits received;
- Signal strength – the strength of the signal received from the radio station. This is helpful in identifying if error rates are due to weak reception;
- Latitude – latitude recorded by the GPS for the location of the receiving vehicle at that moment;
- Longitude – the longitude recorded by the GPS for the location of the receiving vehicle at that moment; and
- Altitude - the longitude recorded by the GPS for the location of the receiving vehicle at that moment.

The analysis in Section 5 will focus on data rates, bit error rates and the ability of the system to reliably broadcast data over large areas.



## 4.2 MIKROS TESTING METHODOLOGY

The Mikros testing took place in September of 1999, with KTLK as the broadcaster. Testing took place over a six-day period, using three different vehicles and different drivers for each.

### 4.2.1 Testing Location

The Mikros testing took place entirely to the east of the Continental Divide, in Eastern Colorado and, on one day, Southern Wyoming. A diverse mix of routes was chosen that covered rural and urban areas. The testing covered a range of elevations from 5,000 to nearly 11,000 feet and was evenly distributed between travel on the mountains and plains. Table 2 is a summary of the routes driven. Figure 9. is a map of the routes in relation to KTLK.



Figure 9. Mikros Test Routes

	Location	Route	Direction	Miles traveled
<b>Day One</b>	Denver	US 36	NW	15
	Broomfield	US 287	N	84
	Virginia Dale	US 287	NE	18
	Cheyenne	I - 80	E	12
	Denver	I - 25	S	97
	<b>Total</b>			<b>226</b>
<b>Day Two</b>	Denver	I - 76	NE	12
	Junction I-76 and US 85	US 85	N	42
	Greeley	US 34	E	34
	Wiggins	CO 39	N	9
	Goodrich	CO 144	E	20
	Fort Morgan	US 34	NE	43
	Sterling	I -76	SW	113
	<b>Total</b>			<b>273</b>
<b>Day Three</b>	Denver	I - 70	E	46
	Byers	US 36	E	76
	Cope	CO 59	S	26
	Seibert	I - 70	W	53
	Junction I-70 and CO 86	CO 86	W	52
	Frank Town	CO 83	N	30
	<b>Total</b>			<b>283</b>
<b>Day Four</b>	Denver	I - 25	S	109
	Pueblo	US 50	W	45
	Royal Gorge	CO 9	NW	65
	Fairplay	US 285	NE	75
	<b>Total</b>			<b>294</b>
<b>Day Five</b>	Denver	I - 70	W	60
	Dillon	CO 9	NW	38
	Kremmling	US 40	E	27
	Granby	US 40	S	47
	Empire	I - 70	E	12
	US 6	US 6	E	25
	<b>Total</b>			<b>209</b>
<b>Day Six</b>	Denver	US 36	NW	25
	Boulder	US 36	NW	38
	Estes Park	US 34	W	54
	Granby	CO 125	NW	54
	Walden	CO 14	E	103
	Ft. Collins	I - 25	S	50
	<b>Total</b>			<b>324</b>
	<b>Total, all days</b>			<b>1609</b>

Table 2. Mikros Testing Routes Traveled

#### **4.2.2 Test Procedures**

Testing began around eight a.m. each day from a location in north Denver. The test vehicle was equipped with an AM antenna, the receiver/DSP unit built by Mikros, and a laptop computer equipped with the Data Logger software. The laptop and receiver/DSP plugged into the car's twelve-volt adapter.

There were two people in the testing vehicle, a driver and a navigator who also operated the equipment. This required insuring the equipment was receiving power, restarting the receiver after the car had stopped, such as for gas or lunch, and monitoring the onscreen display to verify that the signal was received.

Because there was no GPS receiver to document location, the navigator also noted the location and time every five minutes. This information was then related to the time stamp on the data collected. A location was interpolated for all data collected between the five-minute intervals.

During the first day's testing, which was the route from Denver to Cheyenne and back, problems with the receiver/DSP were encountered. These were apparently due to a loose wire that occurred in shipping the equipment from Mikros' offices in Pennsylvania to Colorado. This was repaired, and the remaining five days of testing occurred without difficulty.

After the third day, it was determined that the system was not receiving the signal over as wide an area as expected, given the KTLK's coverage (Figure 1). While the audible signal could be received for over one hundred miles from the radio station, the data reception was lost more than 20 miles away. Mikros examined the system and determined that the receiver was not optimally designed.

Because this test was to assess the feasibility of the broadcast method, not the breadbox receiver, the project team decided to add an amplifier to the antenna in hopes of boosting the reception area. This low-power amplifier was added on the fifth and sixth days, but no appreciable gain was detected.

## 5. TECHNICAL TEST RESULTS

This section summarizes the results of the tests of both systems. The emphasis is on the feasibility of each system to transmit data to travelers. The analysis examines the following:

- Coverage – the area that a single broadcast can cover;
- Data rate – the rate at which data or messages can be transmitted;
- Error rate – the accuracy of the received messages, both ideally and as a function of distance from the broadcast tower;
- Reliability – a qualitative analysis of ambient impacts that may reduce each system’s accuracy; and
- Effectiveness – the ability of the system to transmit traveler information.

### 5.1 HERALD TEST RESULTS

Significant data was collected for the Herald system during the day and at night and the ability of Herald to broadcast data was successful. The system delivered the expected amount of data, but encountered some obstacles that can be resolved with modification discussed in Section 6.

#### 5.1.1 *Data Rate*

The Herald data rate initially predicted by MDS was approximately 125 bits per second (bps) after error correction. In actuality, a rate around 120 was observed by the in-vehicle equipment. On occasions, it dropped to significantly lower levels, but this is mostly due to the synchronization problem previously discussed.

When the vehicle went under an obstruction, such as a power line, tunnel or bridge, the receiver lost the signal and did not receive any data for up to 30 seconds. If several obstructions occurred in a short period of time, it negatively affects the measured data rate.

Figure 10 shows the data rate by time of day for the December 11-12 testing. Figure 11 shows the data rate by distance. These measures include all bits received, both correct and errors, and the effective data rate is considerably lower once bit errors are subtracted.

It appears from this testing the data rate did not suffer as a result of distance from the broadcast tower. It did, however, drop considerably at dusk and dawn. These are the times when KTLK broadcasts at its nighttime power of 1000 Watts and the waves do not propagate as they do during deeper night.

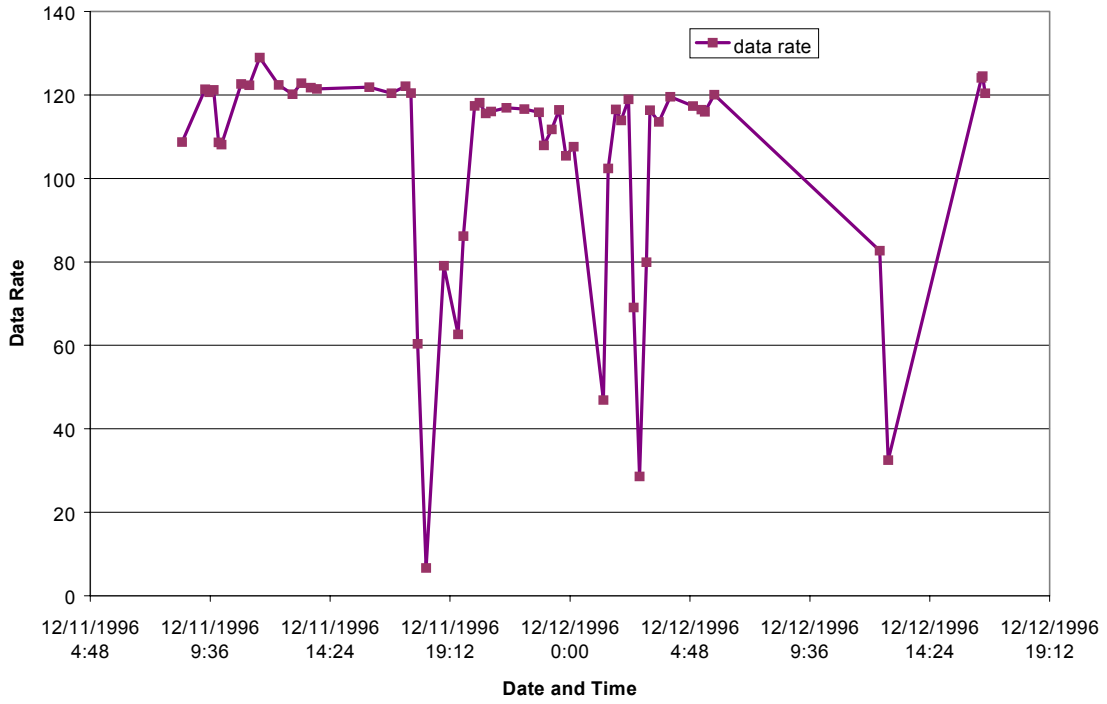

Figure 10. Herald Data Rate by Time of Day

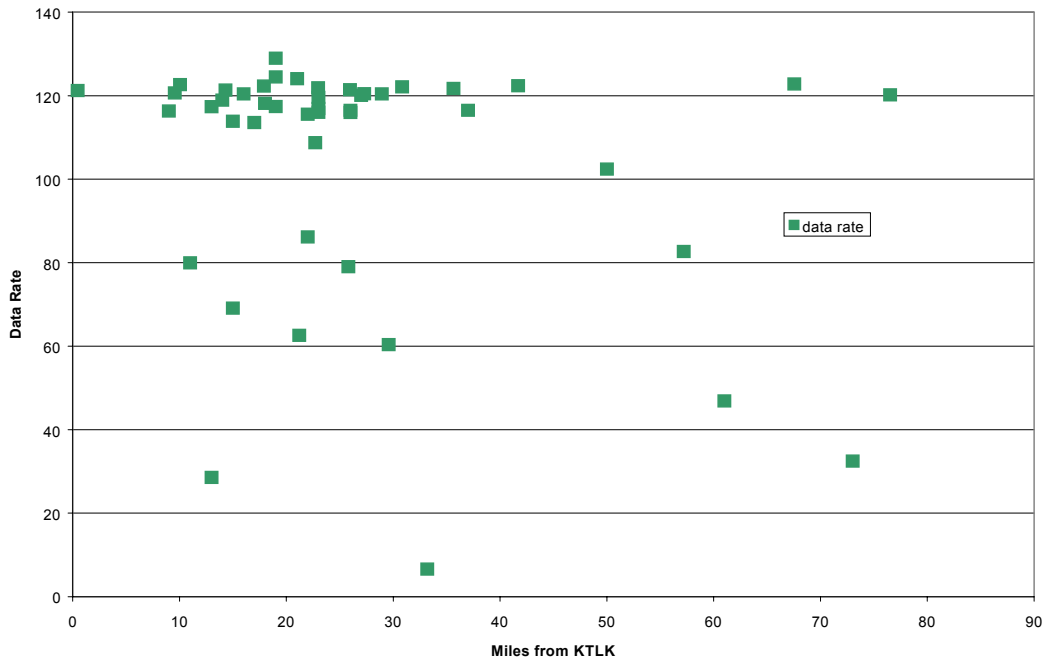

Figure 11. Herald Data Rate by Distance from KTLK

### 5.1.2 Error Rates

There are two measures of error rates discussed here. The first is the bit error rate (BER), which is the raw number of bits in error as a percentage of all bits received. The second is the percentage of messages flawlessly received as a percentage of all messages received.

The bit error rate can be deceptive because it does not explain how and when the errors were received. It does not consider whether they were received in bursts, where a large block of errors is received followed by a block of good bits, or whether the errors are randomly spread throughout the data stream. The difference is critical to the Herald system, where a typical traveler message is about 40 bits. If errors are randomly distributed throughout the data stream, there may be very few good messages that reach the traveler. However, if errors occur in bursts, then it is likely that many good messages may get through.

The experience of this test was that while the receiver was close to the broadcast tower, errors were mostly of the burst type, from disruptions such as tunnels, bridges and electrical lines. This resulted in an occasionally high bit error rate, but the errors only corrupted a small portion of the 40-bit messages. As the receiver moved away from the station, there were the same burst errors, but the system had more random errors as the signal got weaker.

Figures 12 and 13 show the raw bit error rate by time and distance. Figures 14 and 15 show the percentage of good messages that were received as functions of time and distance.

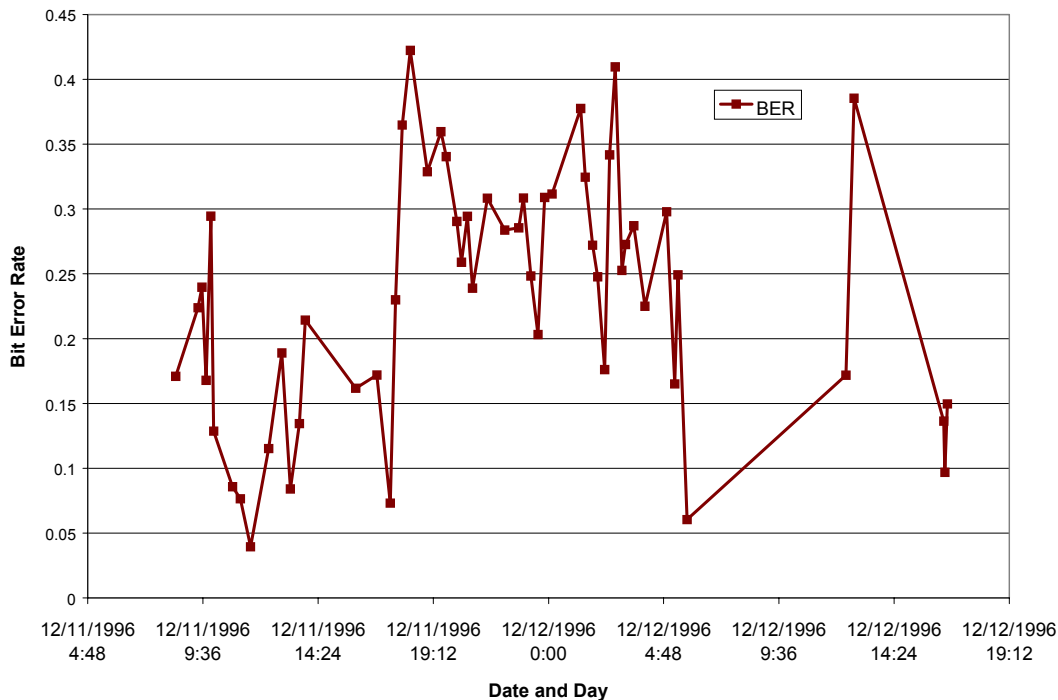

Figure 12. Bit Error Rate by Time of Day

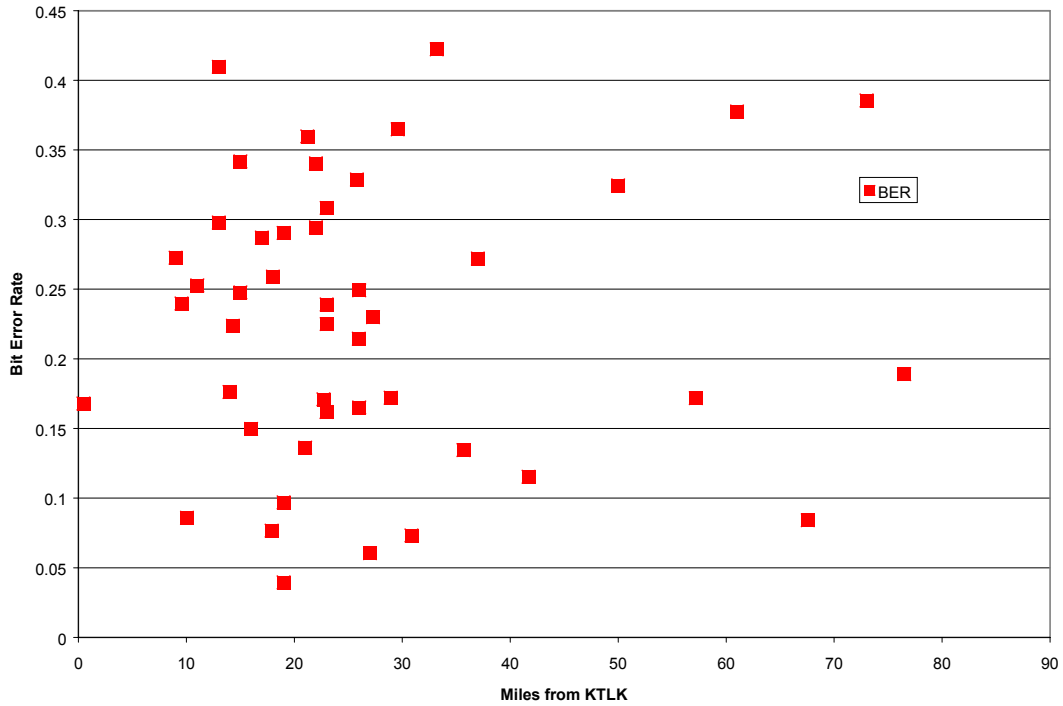

Figure 13. Bit Error Rate By Distance from KTLK

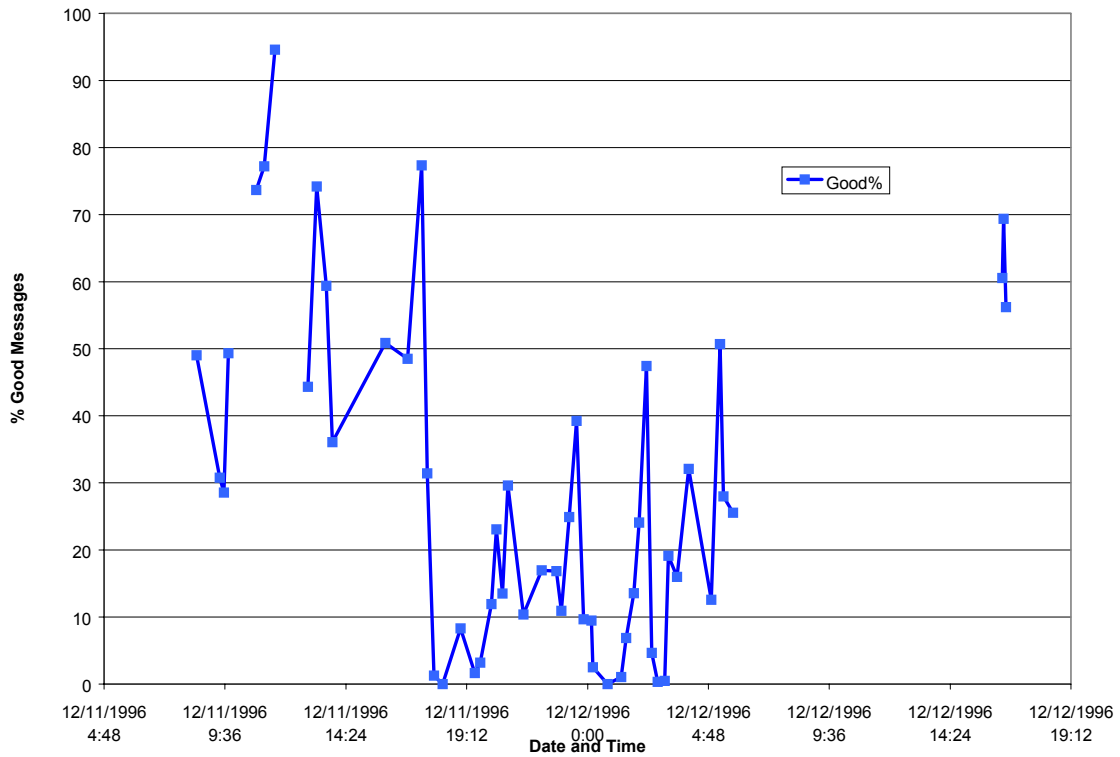

Figure 14. % of Good Messages by Time of Day

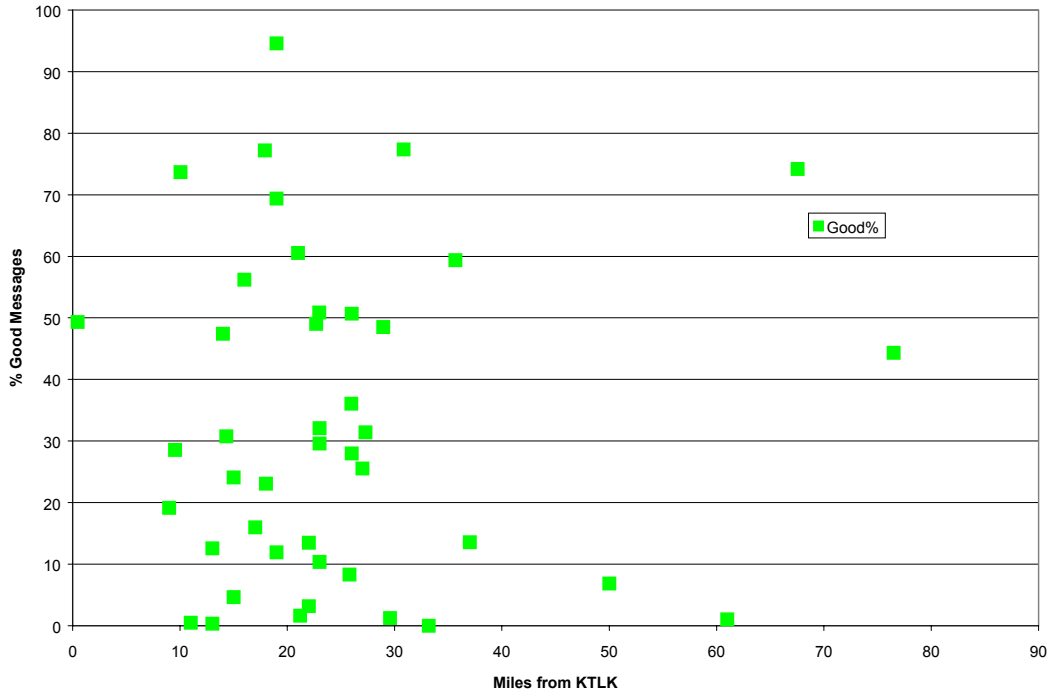

Figure 15. % of Good Messages by Distance from KTLK

The error rates for Herald appear to be high. It is also apparent that the majority of the errors are from identifiable causes that can be remedied. The weak nighttime reception is the result of the reduction in power at KTLK from dusk to dawn. This problem might be resolved through the use of a clear channel, full-time 50,000 Watt station.

The high error rate is the result of the software chosen to identify the data stream patterns in the receiver. It resulted in the loss of large amounts of data any time there was a disruption. MDS was working on improving this software when it went out of business. Other radio engineers indicated a solution without modifying anything but the receiver software portion of the Herald system. In fact, within the data where there are no disruptions, there are large segments where the error rates were less than 1%.

In Phase I testing, the system achieved error rates of less than 0.5% when stationary, and rates of less than 5% in a limited mobile environment<sup>1</sup>. Those rates are achievable in a wide-scale mobile deployment with improved software.

### 5.1.3 Effectiveness of Herald to Disseminate Traveler Information

#### Message Rate

The 120 bps rate of Herald is entirely adequate for rural ATIS. The ENTERPRISE BIF describes a complete traveler message that would be less than 40 bits in length. A Herald system would then be able to broadcast three messages per second, or 180 messages per minute (120bps \* 60 seconds / 40 bits per message).

<sup>1</sup> Mobile Data Systems, Herald Phase I Final Report, March 16, 1996.



### Frequency of Messages

In severe winter conditions, online road and weather information sites will broadcast as many as 80 unique messages within a state. During summer months or times of few weather and construction incidents, the number of messages will drop to ten or less.

At a data rate of 120 bps, the Herald system would be capable of broadcasting all relevant messages at least twice every minute (180 messages per minute / 80 messages).

### Reaching 95% of receivers with Correct Messages

The likelihood of reaching 95% of receivers with correct messages is dependent on the ratio of good messages to all messages. It is assumed that the bad messages are identified by the Herald system and discarded. Table 3 shows how many times a message must be repeated to insure that different percentages of all receivers receive it correctly.

% of messages being received as good	# of repeated messages required to reach				
	95% of receivers	90% of receivers	85% of receivers	80% of receivers	75% of receivers
90%	2	1	1	1	1
80%	2	2	2	1	1
70%	3	2	2	2	2
60%	4	3	3	2	2
50%	5	4	3	3	2
40%	6	5	4	3	3

*Table 3. Number of repeated messages to reach 95% of receivers with correct message*

Table 3 assumes that the rate of good messages is measured at the individual receiver and is dependent only upon conditions at the receiver. It also assumes that the messages are sent correctly and that the distribution of receivers correctly or incorrectly receiving each message is random.

The frequency of a message repeating is dependent upon the number of messages being broadcast. Table Four uses a message rate of three per minute (120 bps/40 bits per message) to determine how quickly a receiver would receive a message (in minutes) based on varying percentages of good messages and the number of unique messages being broadcast in series.

Unique Messages broadcast	% good messages					
	90%	80%	70%	60%	50%	40%
10	7 sec.	7 sec.	10 sec.	13 sec.	17 sec.	20 sec.
20	13 sec.	13 sec.	20 sec.	27 sec.	33 sec.	40 sec.
30	20 sec.	20 sec.	30 sec.	40 sec.	50 sec.	60 sec.
40	27 sec.	27 sec.	40 sec.	53 sec.	67 sec.	80 sec.
50	33 sec.	33 sec.	50 sec.	67 sec.	83 sec.	100 sec.
60	40 sec.	40 sec.	60 sec.	80 sec.	100 sec.	120 sec.
70	47 sec.	47 sec.	70 sec.	93 sec.	117 sec.	140 sec.
80	53 sec.	53 sec.	80 sec.	107 sec.	133 sec.	160 sec.

*Table 4. Time for 95% of vehicles to receive correct message*

Table 4. demonstrates that even during worst case conditions, with a good message percentage of only 40%, it will take less than three minutes to reach vehicles with the correct message.

#### Time to Receive Messages Upon Start-Up

Starting the car often acted as a disruption for Herald, and the result was that no data was received for as long as 30 seconds due to synchronization issues. As has been documented here, there appears to be a solution to the synchronization issues that could reduce the start-up delay to a few seconds.

## **5.2 MIKROS**

The Mikros system was developed to transmit as much as 28,800 bps, but during this testing Mikros was only attempting to transmit 3000 bps in order to insure accuracy. Because the data documented during the Mikros testing was recorded in an unusable format by the evaluation team, this brief summary is based on the observational data collected by CRC staff during the testing.

### **5.2.1 Mikros Coverage**

As previously discussed, the Mikros system had a limited range where it could effectively transmit data. Outside the limited range, the error rate rose quickly. The coverage map was created from observations. As the receiving vehicle traveled away from the radio station, the passenger documented signal strength, error rate and vehicle location. Figure 16. shows an interpolation of the coverage between actual data points. The coverage area is the area where observed error rate was less than one percent.

Based on the testing experiences of the Mikros system for both transmission and reception, the reliable coverage was no more than 30 miles from the broadcast tower in

the direction the antennas were pointed, and no more than 20 miles in the weaker signal direction.

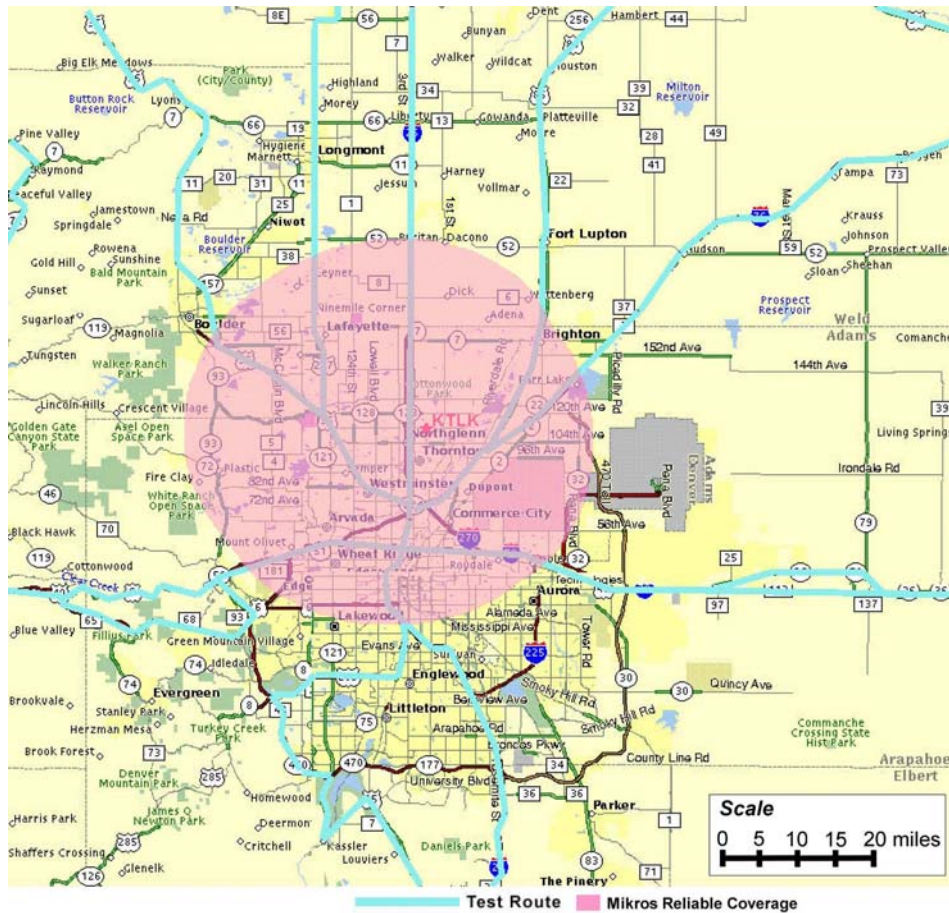

Map Source: U.S. Census Bureau

Figure 16. Mikros System Coverage

It is noted that the signal strength documented by the testers was still strong well beyond the coverage achieved by the system, which suggests a poor receiver.

### 5.2.2 Mikros Data Rates

There were no recorded data rates available for this evaluation. However, the Mikros system was observed to transfer data at rates over 3000 bps during this test. These speeds were constant over distance, but were reliably received within twenty miles of the radio station.

No night testing occurred with the Mikros equipment because it was directly connected to KTLK's daytime broadcast equipment and not switched over to the nighttime equipment.

## 6. INSTITUTIONAL ISSUES

This section discusses the institutional issues that may have presented obstacles to the deployment of Herald. There are two primary types of issues that posed potential obstacles: legal and commercial. The legal issues were formally explored during the Herald development. Commercial issues were explored by testing for radio station interest in the system.

### 6.1 LEGAL ISSUES

In order for Herald to be deployed, it was necessary to determine whether its development would violate any existing patents or copyrights. The Herald system is intended as an open and non-proprietary system, and therefore could not rely on any proprietary technology. The second major legal issue was determining the legality under FCC regulations for broadcasting digital data on an AM subcarrier.

#### *6.1.1 Patent and Copyright*

MDS did a patent search during the first phase of Herald and determined that the system they were developing did not conflict with any patents. The review included an investigation into European systems of similar design.

#### *6.1.2 Federal Communication Commission Regulations*

During Phase I, MSI employed the law firm of Hatfield and Dawson to write an opinion on FCC regulations concerning digital AM subcarrier broadcasts. They determined that the FCC “makes clear that such data or other transmissions are specifically permitted.” The FCC requires that such use “does not disrupt or degrade the station’s own programs or the programs of other broadcast stations.”<sup>2</sup> As the Herald system was designed, it does not in any way disrupt the audible program. And because it is contained within the bandwidth of the audio content, it cannot possibly disrupt the programs on other channels.

However, the Herald system did degrade the audio quality on stereo AM radios. It did not disrupt the program, but rather fooled the stereo AM radios into incorrectly demodulating the program. It is unclear whether this is a violation of the FCC regulation, but it also has a simple remedy, as described in Section 7.

---

<sup>2</sup> Letter to MSI, 12/18/1995, Benjamin F. Dawson III, Hatfield and Dawson  
*Herald Field Operational Test -September 2000*

## 6.2 COMMERCIAL ISSUES

There are several issues related to the deployment of Herald or Mikros that are the result of its potential operation as a cooperation between the public and private sector. The feasibility of Herald and Mikros systems for broadcasting traveler information is dependent on their ability to integrate into the existing AM infrastructure.

### 6.2.1 *Potential Service Providers*

The majority of AM stations could be a carrier for Herald or the Mikros system. The only ones that would not be able to are those that broadcast in stereo, because both systems would interfere with the stereo broadcast. The FCC does not keep records on the number of AM stations using stereo<sup>3</sup>, but it is a small percentage of all AM stations.

The power of a station's broadcast does not affect the Herald system's ability. Herald Phase I testing was done using a 10 watt station, and the results were positive, although the geographic range was severely limited. The Mikros system was moved from a 5,000 Watt station to the 50,000 KTLK for this testing with only slight modifications.

Frequencies set aside for local, state and federal agencies to broadcast weather and traveler information, such as 530 AM and 1610 AM are usually low-powered transmitters intended to cover a specific, small area. The 10 Watt stations are likely too small to effectively transmit data over more than a mile, but the larger stations provide Herald and Mikros an existing broadcast infrastructure that is never broadcast in stereo.

### 6.2.2 *Competing Demand for AM Data Broadcasting*

The main competition for the Herald and Mikros in broadcasting data is the conversion of AM stations to stereo. However, stereo has not expanded beyond a small percentage of stations and none of the rural stations observed in Colorado were broadcasting in stereo.

There is the potential for competition between Mikros and Herald. The Mikros system is commercially funded and may eventually be deployed on a wide-scale as a for-profit venture. This may include transmitting data for pagers, remote equipment operation, and other private data streams. Because Mikros will be for-profit, its data broadcasts will be used for revenue-generating purposes. An agency seeking to broadcast traveler information would have to develop a model for generating revenue through the broadcast of traveler information, either through subscriber fees, or by having the agency generating the messages pay for all or part of the available bandwidth. Herald and the Mikros system cannot coexist on the same station.

---

<sup>3</sup> <http://www.fcc.gov/mmb/asd/bickel/amstereo.html>, October 26, 1997

The other major competition for Herald and Mikros can be observed on FM stations. The subcarrier is being used to broadcast station information, such as the call letters and the type of programming. With modern, more sophisticated radios, the subcarrier is used to inform the radio of other stations carrying the same programming. If the station being listened to fades away, the radio will automatically search the other known stations for a better signal. These functions are gaining support in the FM industry and may eventually be carried over to AM.

### ***6.2.3 Service Provider Acceptance***

Because Herald and Mikros systems offers the potential for generating additional revenue for radio stations, it appears that radio stations are very interested and supportive of its development. KTLK provided support for both the Herald and Mikros systems testing at no cost. The station owner, Clear Channel Communications, Inc. is a publicly traded company that owns 183 radio stations in North America and their motivation was to find ways to increase revenue from their existing stations.

Clear Channel owns modern stations primarily in metropolitan areas. In contrast, rural AM stations have a wide range of technical expertise and equipment. Some stations have not upgraded in decades, while others have state-of-the-art operations. The ease with which Herald or Mikros equipment integrates into these stations may vary. Additionally, many rural stations are independently owned, which makes developing a network of stations more difficult as it would require dealing with multiple companies.

In order to insure the long-term viability of AM data broadcasting, a revenue stream must be developed. This may be through subscriber fees or funding directly from transportation agencies to the stations. If a profitable revenue stream can be demonstrated, it is expected that stations will provide full support and participation in a Herald or Mikros system.

It is unclear whether large corporations would support an outside agency providing data programming, such as traveler information, on their channels. In FM, most stations broadcasting data generate it themselves. However, there have been extensive tests, most notably in Arizona, Minnesota and Washington, where state agencies have provided traveler information on the FM subcarriers of commercial stations.

## 7. RECOMMENDATIONS

In this section, several technical recommendations to improve the Herald and Mikros AM subcarrier systems are made. These recommendations do not take other technologies or developments into consideration. It focuses on the existing systems and potential ways to improve their operation and feasibility for successful deployment.

### 7.1 HERALD

There were multiple issues that prevent Herald from being put into operation until they are resolved. These issues could appear to be solvable, with slight software and operating modifications. In fact, MDS was working on resolving the issues when they went out of business and ceased operations.

#### *7.1.1 Prevent Triggering AM Stereo Pilot Tones*

The reason Herald testing was cut short by KTLK was because when Motorola AM stereo radios heard the Herald broadcast layered onto an existing broadcast, it mistook it for a stereo signal, and the result was a noticeably degraded sound. According to radio engineers, this problem can be resolved with a “notch” filter.

Any tone at 25 Hz off the broadcast frequency is within the silent subcarrier, but in Motorola AM car stereos, it is the “pilot tone” that informs the radio the incoming broadcast is stereophonic. Because the subcarrier spread out 100 Hz on either side of the channel frequency, it included the pilot tone.

A notch filter would “notch” out the portion of the Herald broadcast around 25Hz. This would resolve the issue with Motorola AM car stereos. However, it would also eliminate some bandwidth, resulting in lowered data rates. The reduction would likely be by around 20 bps, from 120 bps to 100 bps. The presence of a notch filter most likely would have resulted in a much longer test since KTLK listeners would have encountered virtually no noise interference.

Figure 17. illustrates the effect of the notch filter on the subcarrier.

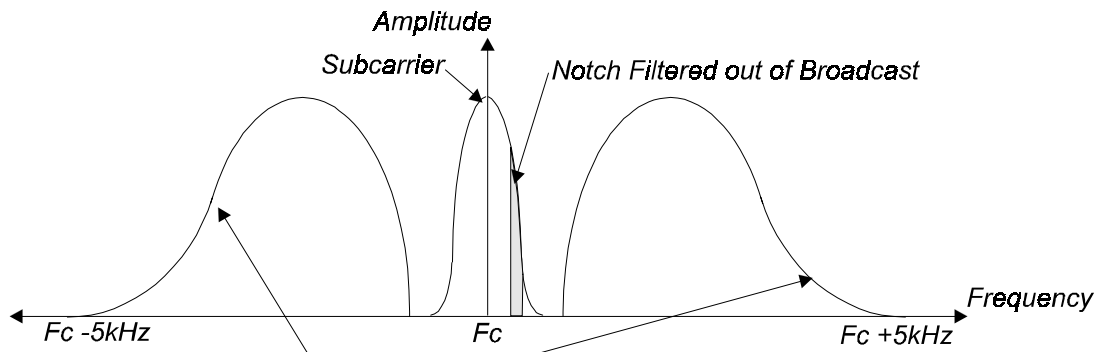

Audio Program  
 Figure 17. A notch filter in the AM subcarrier

### 7.1.2 Improve synchronization

When the reception of the broadcast was disrupted by temporary loss of reception due to power lines, bridges or other obstacles, the receiver continued to hunt for the rest of the message it was in the process of receiving. The receiver continued to seek the completion of the message until its algorithm could recognize the incoming bit stream and the location within that stream that it was at. When the receiver picks up a bit stream after a disruption, it can recognize the bits, but it does not know if the next bit is the beginning, middle or end of a byte (8-bit set). Once it recognizes the beginning of a byte, it must identify whether it is the beginning, middle or end byte of a block (for Herald, blocks were five bytes). Once the receiver can synchronize the bytes and blocks, it is able to recognize complete messages.

In Herald, several messages and headers can be received every second. However, the Herald system did not synchronize right after a disruption. In some cases it took as long as 30 seconds before it recognized a complete message. This resulted in a large percentage of the observed errors.

It is not clear why the Herald system failed to resynchronize, but it is essential that this problem be corrected before the system becomes commercially feasible. MDS began work on resolving this problem before going out of business and no working solution was developed.

An improved algorithm for detecting and recognizing the incoming data stream will reduce the synchronization time to a fraction of a second. This would improve system reliability and the speed with which travelers can receive messages.



## 7.2 MIKROS

The Mikros system is the result of a much larger and more expensive development process than the Herald system. It is a system that has received considerable testing by its manufacturers.

The primary recommendation of this evaluation is that Mikros continue private-sector development of its AM technology, specifically the enhancement of the existing receiver, or the development of a new receiver.

Because the Mikros system is proprietary it is unclear what improvements can be made to the broadcast part of the system. However, based on the comments of the evaluation's radio engineer and Mikros, the receiver is the likely place for improvement.

An improved receiver will improve the range from the observed 20-25 miles to something that will be more beneficial in rural areas. However, Mikros does not normally develop receivers. They should work with a company who does and identify a way to modify an existing car radio to receive the data stream. The advantages would be to more clearly illustrate the ease of integrating the Mikros system into existing technology, and to take advantage of the superior receivers available in most high-end cars.

This improved receiver should be tested not only for data rate but for range, to determine if the system is a feasible rural information dissemination solution.

## 8. CONCLUSIONS

Herald began in 1993 and the system development took place from 1994 to 1996. In the proceeding years, the demand for rural traveler information has dramatically increased. The need for a Herald type system to reach rural travelers en-route has increased.

While there has been significant strides at the local, state and federal level to collect better road and weather information in rural areas, the means of disseminating are still limited by the communications infrastructure. The trip planning element is addressed by systems such as dial-in and web sites. However, there is still a need for a low-cost means of keeping travelers informed once they are en-route. The goal of Herald was to identify whether it would serve this need, and the results of these tests indicate that it can.

Herald proved that an AM subcarrier is able to disseminate traveler information over a wide area. The data rate was as expected, and the error rate was higher than expected. However, as discussed in Section 7, the error rate may be easily remedied.

### 8.1 POTENTIAL MARKET FOR HERALD

The Herald or Mikros system have a significant potential as a communications means for ATIS. No other data medium can reach as much of the rural areas, and the cost of broadcasting and receiving data are much lower than any other option.

While the initial focus was on in-vehicle devices, the need is now for communications to both PDAs and in-vehicle systems. Through a low-cost antenna and data demodulator, traveler information messages can be received and displayed on PDAs. The advantage of PDAs is the built in display screen that allows for graphics and text. Travelers would be able to use PDAs both in and out of their vehicle.

In addition, improvements in GPS and its expanding use mean that Herald or Mikros can target their information to location-specific users. Using the ENTERPRISE developed ITIS message codes, all messages can be coded with a location reference. Combined with an in-vehicle or PDA GPS receiver, it is possible for the user to receive location-specific information. If the location reference in a message corresponds to the user's location, as determined by the GPS, the message would be displayed. If the locations do not correspond, the message would be ignored. Similarly, drivers could be able to predetermine which types of messages they would like to see, from low to high priority, which is also part of the ENTERPRISE coding.

A potential market for Herald technology is in third-world countries where news is not well-disseminated. As previously noted, the Herald system is able to send out text messages. Since AM can cover a wide area and the display units are inexpensive, Herald

could be deployed to provide information such as calendars or news to areas that otherwise do not receive it in printed format.

## **8.2 RECOMMENDATIONS FOR FUTURE RESEARCH**

It is clear that both the Herald and Mikros system can be developed into suitable low-cost ATIS broadcasting methods. Herald took the first step in verifying their technical feasibility.

Improvements are needed in both systems. Mikros is continuing its development in the private sector. Herald is open and non-proprietary and can be further developed by any entity. It is believed that its further development can be done inexpensively and quickly.

Future research should focus on an actual deployment of traveler information over a large rural area. It should go beyond testing into operation and test the usefulness of a Herald system for travelers. The deployment should include a large number of in-vehicle devices and PDAs distributed to typical rural travelers, and it should investigate the following:

- The ease of use of traveler messages en-route in a rural environment;
- The effect of this information on travel patterns;
- The improved safety and reduced travel times that may result;
- The speed with which messages are received;
- The coverage of an improved Herald or Mikros system;
- The cost of modifying PDAs or in-vehicle equipment;
- The acceptance of equipment by rural Am broadcasters; and
- Potential revenue streams for Herald or Mikros.

The next level of testing and deployment should lead to a commercial deployment that is financially sustainable and can cover other areas.

## 9 ACRONYMS

AM	Amplitude Modulation
ATIS	Advanced Traveler Information Systems
BAP	Bearer Application Protocol
BER	Bit Error Rate
BIF	Bearer Independent Format
BPS	Bits Per Second
CRC	Castle Rock Consultants
DSP	Digital Signal Processor
FCC	Federal Communications Commission
FM	Frequency Modulation
FHWA	Federal Highway Administration
GPS	Global Positioning System
ISI	Intersymbol Interference
ITS	Intelligent Transportation Information Interchange Systems
MDS	Mobile Data Systems
Mikros	Mikros Systems Corporation
MSI	Modulation Sciences, Inc.
NRZ	Non-return to Zero
NTIA	National Telecommunications and Information Administration
PDA	Personal digital Assistant
RBDS	Radio Digital Broadcast Systems
SDO	Standards Development Organization

## 10 BIBLIOGRAPHY

1. Black, Harold S. 1953. Modulation Theory. Princeton, New Jersey: D. Van Nostrand Company, Inc.
2. Carr, Joseph J. 1978. Elements of Electronic Communications. Reston, Virginia: Reston Publishing Company, Inc.
3. Carson, Ralph S. 1990. Radio Communications Concepts: Analog. New York: John Wiley & Sons.
4. Dawson, Benjamin F. III, P.E., Letter to MDS, Hatfield and Dawson, December 18, 1995.
5. Federal Communications Commission, AM Stereo Broadcasting, <http://www.fcc.gov/mmb/asd/bickel/amstereo.html>, October 27, 1997.
6. Lemmon, John J., "Area Coverage for an AM Subcarrier System," Institute for Telecommunication Sciences, National Telecommunications and Information Administration, Boulder, CO.
7. Linnartz, J., "Spectrum Efficiency of Radio Data Systems," IEEE Trans. On Broadcasting, Vol. 39, pp. 331-334, September, 1993.
8. Mobile Data Systems, 1996, Herald: Simulate Systems and Select Design.
9. Radio Design Group. How it works: Radios. <http://www.radiodesign.com/radwrks.htm>
10. University of California Department of Engineering, Catch a Wave: How Radio Works, <http://www.usc.edu/dept/engineering/illuminate/textver/Radio.htm>